

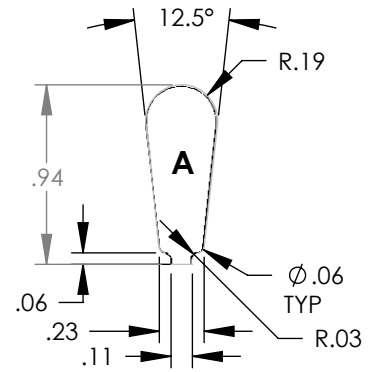

"MADE IN THE USA"

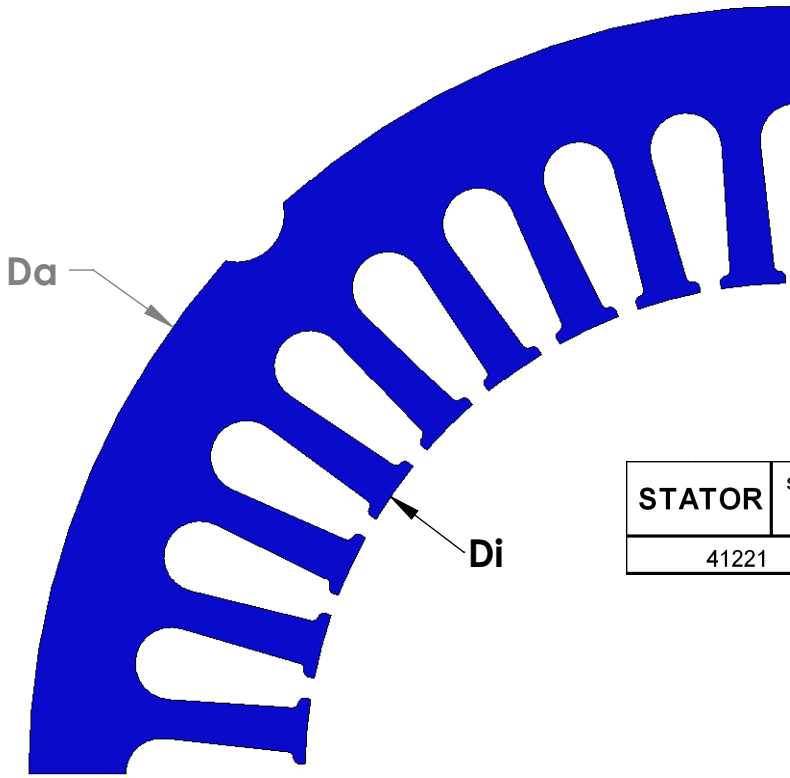

STATOR	SLOT A	CHARACTERISTICS			
		D _a	D _i	N	A
41221		8.00	5.12	36	0.262

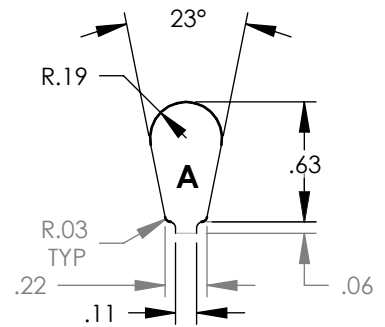
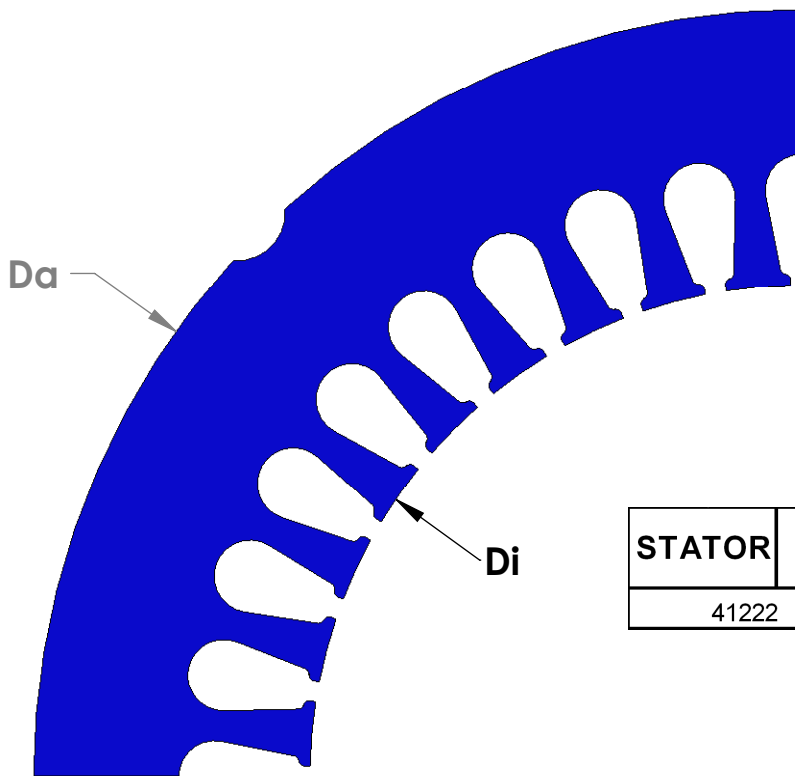

STATOR	SLOT B	CHARACTERISTICS			
		D _a	D _i	N	A
41222		8.00	5.12	36	0.183

NOTE: CORES ARE WELDED
NOT TO SCALE

MATERIAL: SILICON STEEL
DIMENSIONS: INCHES

REULAND ELECTRIC CO.
INDUSTRY, CA HOWELL, MI CINCINNATI, OH